

Article number: 03504160

Description: Fluro Rod end GE 160LO

Measures

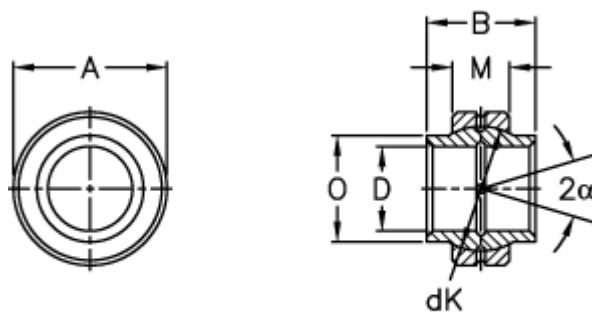

Str. 12 den smørerille

A	= 230 0 -0,030	Tilt angle = 4
B	= 160	Weight = 15800
D	= 160 0 +0,040	
dK	= 200	
Dynamic load C (kN)	= 1370	
M	= 80	
O	= 177	
Static load C0 (kN)	= 6800	